

# Series 1400

## Battery Powered Flow Monitor by Data Industrial

### INTRODUCTION

The Data Industrial 1400 Series is a stand alone, battery powered flow monitoring system providing an accurate reading of the rate of flow as well as total accumulated flow. The system consists of an impeller type sensor and a monitor with digital rate and total displays.

A number of sensor options are offered covering applications for a wide range of pipe sizes. In-line tee type sensors are used for pipe sizes from one to three inch, while insert type are used on all sizes above. Hot tap sensors with isolation valves may be installed under pressure or used on larger diameter pipelines that can't be shut down for service. The flow sensors feature a proven six bladed impeller design with excellent low flow performance and the ability to shed water borne debris. The impeller, bearing and shaft are easily replaced in the field. The 1400 Series sensors feature a magnetic detection technique.

The monitor may be calibrated to the line size in the field via internal switch settings. The Model 1400 housing is a rugged cast aluminum enclosure with a sealed cover. The meter is totally watertight and exceeds NEMA 6P submergence specifications. Flow rate is displayed on a four digit LCD display while the volume is displayed on a seven digit mechanical totalizer, a non-volatile form of memory. The monitor may be mounted directly on the insert type sensor in either a horizontal or vertical orientation, or remotely on a pipe or wall using a watertight connecting cable.

The sensor is self powered. The meter and mechanical counter are powered by a "C" size Lithium TCL cell of 3.7 VDC output. The Meter is designed to require very low current draw for operation. Battery life is affected by the calibration, primarily the resolution of the totalizer, but in most cases should exceed three years.



PN# 72819

7/9/93

### SENSOR MODELS

Data Industrial provides several basic sensor configurations using the same impeller and detection techniques. The 1400 Series sensors are not compatible with other Data Industrial transmitters and monitors, nor are the standard or "IR" sensors compatible with the 1400 display. The 1400 Series sensors are designated "M" sensors and can be distinguished from standard sensors in two ways: The model number containing the letter "M" is printed on the flow direction label on the sensor, and the electrical conductors, which are less than six inches long, terminate in a watertight connector.

Sensor models are described as follows:

#### **MODEL 220-MB**

This insert style sensor is 5-5/8" long, and uses brass and bronze hardware. It is used in all pipe sizes from 2.5" to 20.0" in diameter. A bronze 2" NPT externally threaded mounting adapter is provided. The adapter may be mounted to the pipe using a weld-on threaded fitting, or a saddle. Wetted materials are brass, bronze, Polyphenylene Sulfide (PPS), Tefzel, Ethylene Propylene (EPDM), and Tungsten Carbide.

#### **MODEL 220-MSS**

The same as the Model 220-MB except the sensor sleeve, and mounting adapter are made of 316 stainless steel.

#### **MODEL 225-MB**

This insert style sensor is 16-3/4" long, and uses brass and bronze hardware. It includes a brass gate valve for isolation, and is meant to be used for applications where pipe is drained for initial installation but cannot be drained for service. All other features are similar to Model 220-MB.

#### **MODEL 226-MB**

This is the same as the Model 225-MB except the isolation valve is a full port ball valve. This sensor is meant to be used for actual "hot tap" applications where the installation is made under pressure. The ball valve cannot be fouled by the tailings from the cutting operation. The ball valve is also used in higher pressure applications.

#### **MODEL 226-MSS**

This sensor is the same as the Model 226-MB except that the valve, sensor sleeve and mounting adapter are stainless steel.

#### **Model HTT**

This is the insertion tool for use with any of the Hot Tap Sensor units. It is used to insert and remove the sensor while under pressure. Generally, only one HTT tool is needed on each job site.

#### **Model 228MB, 228MC, and 228MSS**

(2 and 2 1/2" sizes are available in this series.)

#### **Model 228MB**

This model consists of a threaded bronze pipe tee, with a Model 220MB sensor mounted and set to a fixed depth using a modified hex mounting adapter.

#### **Model 228MC**

This is the same as Model 228MB except that a Class 150 cast iron pipe tee is provided with NPT female threads.

#### **Model 228MSS**

This is the same as Model 228MB except that the sleeve, hex adapter and pipe tee are made of 316 stainless steel. The sensor portion of this model is a Model 220MSS.

#### **Model 250MB**

This sensor combines a PPS plastic impeller/detector assembly with a proprietary cast bronze pipe tee with threaded NPT connections for use in pipe sizes of 1", 1 1/4", and 1 1/2".

#### **Model 220MP**

This sensor consists of a modified schedule 80 PVC tee with solvent weld socket end connections, and a removable PPS impeller/detector insert. Available sizes are 1 1/2", 2", 3", 4".

**DISPLAY MODELS**

The 1400 display unit may be used with all the “M” Series sensors listed in the previous section. The circuitry, battery and housing is the same for all sensors, however there is a small difference in mounting hardware depending on the sensor selected.

**MODEL 1401**

This display is furnished with a bronze union tail and nut for coupling to brass insert style sensors.

**MODEL 1402**

This display is furnished with a stainless steel union tail and nut for coupling to stainless steel sensors.

**MODEL 1403**

This display is not furnished with a union and is used with tee type sensors or for remote mounting situations.

**DISPLAY INSTALLATION**

The 1400 Series display unit is shipped from the factory with the face panel, and electrical connections sealed to meet NEMA 6P immersion requirements. If it is necessary to remove the faceplate for calibration or battery change, it must be resealed. Failure to follow the procedure listed below may allow water to enter the housing causing serious damage to the circuits. The warranty does not cover damage caused by a failure to seal the faceplate.

**Sealing Procedure**

Tools Required:

- (1) Phillips #2 Screwdriver
- (1) Torque regulated screwdriver, #2 Phillips pt, set to 12 in/lbs. If meter is installed in a meter pit, or is otherwise exposed to standing water, the following additional tool and lubricant are required:
- (1) Pipe wrench 2" jaw opening, to dismount the display from the sensor
- ... small quantity of Parker O-lube or other water insoluble lubricant compatible with rubber.

1. Make certain that gasket and cover are dry, clean and free of contaminating debris.
2. Pilot the gasket to the cover, using 3 or 4 of the #10-24 screws in the corners. Engage these screws with the appropriate tapped holes in the housing. **DO NOT TIGHTEN.**
3. Using care to prevent jamming or wrinkling the gasket, engage the balance of the #10 screws through the cover and gasket holes and into the housing.
4. Using the #2 Phillips screwdriver, tighten finger tight all 12 screws. Carefully observe contact pattern between gasket and cover. No creases of the gasket and no voids in contact between cover and gasket should be visible. If any such occur, loosen **ALL** screws and repeat.
5. After insuring uniform gasket seating as in step 4 above, tighten all screws using the torque regulated screwdriver set for 8 inch-pounds. Overtorquing or uneven torquing may result in cracking the cover.

**Figure 6: Hardware tightening sequence**

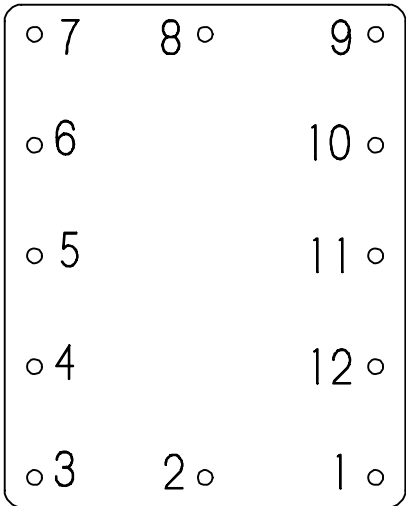

**NOTE! Adequate and uniform torque are essential to maintain the watertight integrity of the enclosure. Overtorquing will result in eventual cracking or breakage of the cover. Too little torque also will not produce a watertight seal. Warranty is voided for any damage due to water intrusion if case, gasket, or seal is not intact.**

6. Then tighten the fasteners to 12 inch-pounds of torque following the sequence shown in Figure 6.

The mounting hardware/electrical connector is tightened to the housing with thread sealant. There is a tap on the back of the housing equipped with a sealed plug. If the alternate tap is used for mounting, both the plug and the mounting hardware must be resealed.

### MOUNTING OPTIONS

#### 1. Direct Coupling to Sensor Vertical Display

The Series 1400 display is equipped with a threaded nipple, union tail piece, and nut that match a union flange furnished with the "M" Series sensor. This hardware is factory installed in the tap at the bottom of the housing and serves as a conduit for the wiring as well as the mount for the display. The sensor should be installed on the pipe to the correct depth and alignment before attempting to mount the display.

To Install, first remove the plastic thread protectors from the union halves.

Apply a small amount of O-ring lubricant (furnished in installation kit) to the ends of the electrical connector.

Align the external ribs of the connector halves and push them together.

Screw the union nut to the flange. Tighten as necessary to hold the display. **Note: It is not necessary to seal the union connection. The electrical connector is watertight.**

#### 2. Alternate mounting to sensor- Horizontal Display

If the flow meter is mounted in a meter pit or valve box and will be viewed from above, the mounting hardware may be attached to the back of the unit through the alternate tap, making the displays horizontal.

First remove the faceplate and the two screws from the right hand corners of the circuit board.

Swing the board open to access the sensor wires red, black and yellow. Grasp the circuit board only, not one of the components.

Disconnect the sensor wire plug from the circuit board.

Remove the mounting hardware with a small pipewrench.

Remove the plug from the back of the housing with a 3/8" Allen wrench.  
Apply pipe sealant to the plug and reinstall in the bottom tap, tightening with the Allen wrench.

Apply pipe sealant to the mounting hardware and reinstall in the tap on the back of the housing.

Reconnect the sensor wires to the circuit board.

Refasten the circuit board screws, and reinstall the cover. Be sure to follow the tightening sequence and torque specifications.

Then proceed to couple the display to the installed sensor as above.

#### 3. Remote Mounted Display

When using tee type flow sensors, or for reasons of convenience, the display may be mounted remotely. Four 1/4-20 NC threaded mounting holes are located on the back. The hole pattern is shown in Figure 7.

For panel mounting; drill holes and attach screws from the back.

For wall mounting; two pieces of “strapping”, longer than the width of the housing, may be attached to the back of the display. Screws, shields or anchors may then be used to fasten the strapping to the wall.

For pipe mounting; flexible metal banding may be cut to length, drilled and fastened to the housing with machine screws.

Connect the display to the sensor using extension cables listed below.

- Part no. 07101 5 foot cable with connectors
- Part no. 07102 20 foot cable with connectors

**NOTE: The Display has been tested at distances up to 100 feet from the Sensor. However, try to keep the distance as short as possible to maintain readings over the life of the battery.**

**Figure 7: Hole pattern for remote mounting**

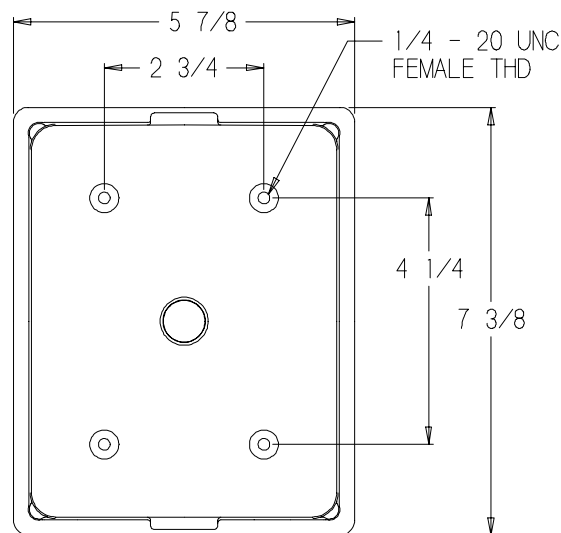

BACK VIEW

**Battery**

The Series 1400 Flowmeter has been operated totally immersed in water for periods exceeding six (6) months, during at least 3 of those months under a 6 foot head. Battery replacement was performed several times during this test, to ensure that no difficulties were encountered. The key to a successful battery replacement is careful reassembly of the Flowmeter cover.

If the flowmeter is located in a well pit, certain additional tools are required beyond those required for a remote mounted meter not exposed to standing water.

**IMPORTANT! BATTERY SAFETY RULES**

The Lithium Thionyl Chloride (LiTCL) battery, that powers the Data Industrial Series 1400 Flowmeter system, contains inflammable materials such as lithium organic solvent, and other chemical ingredients. Explosion or fire may result if the battery is not handled correctly. **To avoid accidents follow these guidelines:**

- DO** replace only with a C size, 3.7 Volt LiTCL battery as specified below.
- DO** install new batteries with correct polarity
- DO** dispose of used batteries correctly
- DO NOT** stack or jumble up batteries
- DO NOT** heat batteries above 95° C
- DO NOT** attempt to disassemble batteries
- DO NOT** attempt to recharge batteries
- DO NOT** apply pressure to, crush, or deform batteries
- DO NOT** solder to batteries
- DO NOT** dispose of batteries in fire

**Figure 8: Cover and Gasket Removal**

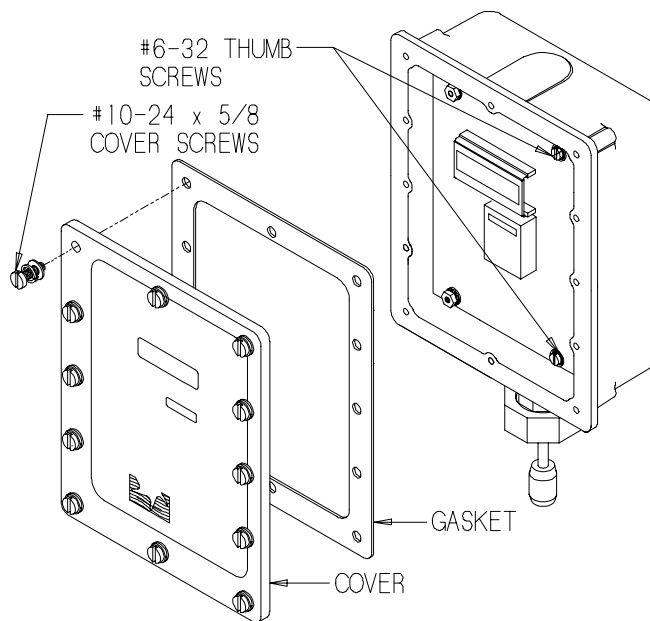

## Battery Replacement Instructions

Tools required:

- (1) Phillips #2 Screwdriver
- (1) Torque regulated screwdriver, #2 Phillips point, preset to 12 inch-pounds
- (1) Replacement battery, C size Lithium TiCl type, 3.7 volt "Eternacell" T52/41 by Power Conversion Inc. or equivalent
- (1) Plastic bag or other suitable container large enough to contain the old battery

If meter is installed in a well pit, or is otherwise exposed to standing water, the following additional tool and lubricant are required:

- (1) 2" pipe wrench, for dismounting the meter from the sensor

... Small quantity of Parker O-Lube or other water insoluble lubricant compatible with rubber.

## Battery Replacement Procedure

### 1. If the flowmeter is coupled directly to the sensor, and located in a well pit or in standing water:

- a. Using the 2" pipe wrench, uncouple the Union Nut connecting the meter to the sensor.
- b. Carefully lift the meter away from the sensor, to expose the plug and socket connection in the interconnecting wires.
- c. Grasping the ends of the socket and plug, pull to release meter from sensor.
- d. Remove meter to a clean, dry location and clean up exterior of all water and other debris.

### 2. Gain Access to Battery

- a. Using Phillips #2 Screwdriver, remove 12 #10-32 screws, and their mating washers and lockwashers.
- b. Remove cover and gasket to a clean, dry location.
- c. Remove two #6-32 thumbscrews from the upper and lower corners of the right hand edge of the PC board.
- d. Carefully swing the thumbscrew side of the PC board outward on its hinges.

**Figure 9: Opening the battery cavity**

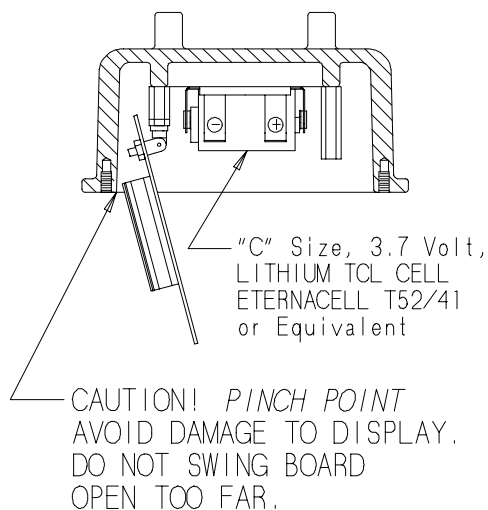

**DO NOT use components as handles to open board.**

**DO NOT swing wide open. USE CAUTION to prevent damage to display and other components caused by jamming against the enclosure.**

### 3. Replace battery

- a. Remove old battery from holder and place it in the protective plastic bag.
- b. Install new battery in holder, with correct polarity.

### 4. Gasket and cover replacement

- a. Close battery cavity by swinging PC board back into closed position. Secure with #6-32 thumbscrews.
- b. Make certain that gasket and cover are dry, clean and free of contaminating debris.
- c. Pilot the gasket to the cover, using 3 or 4 of the #10-24 screws in the corners. Engage these screws with the appropriate tapped holes in the housing. **DO NOT TIGHTEN.**
- d. Using care to prevent jamming or wrinkling the gasket, engage the balance of the #10 screws through the cover and gasket holes and into the housing.
- e. Using the #2 Phillips screwdriver, tighten finger tight all 12 screws. Carefully observe contact pattern between gasket and cover. No creases of the gasket and no voids in contact between cover and gasket should be visible. If any such occur, loosen **ALL** screws and repeat.
- f. After insuring uniform gasket seating as in step e above, tighten all screws using the torque regulated screwdriver set for 8 inch-pounds. Overtorquing or uneven torquing may result in cracks developing in the cover.

**NOTE! Adequate and uniform torque are essential to maintain the watertight integrity of the enclosure. Overtorquing will result in eventual cracking or breakage of the cover. Too little torque also will not produce a watertight seal. Warranty is voided for any damage due to water intrusion if case, gasket, or seal is not intact.**

- g. Then tighten the fasteners to 12 inch-pounds of torque following the sequence shown in Figure 6 on page 17.

### 5. Install on sensor (if reqd)

- a. Carefully apply a thin coat of O-ring lube to the plug (male) portion of the plug and socket assembly. **DO NOT** get grease inside the rubber shrouds.
- b. Align incised line on socket shell with the nib on the plug portion, and press home. (Plug and socket will only assemble in proper orientation.)
- c. Stuff excess lead length down into nipple.
- d. Reassemble and tighten coupling union.

### 6. Leave job site, carrying replaced battery in appropriate container for proper disposal.

## Meter Calibration

Figure 10, below identifies all settable jumpers and switches used in calibrating a Series 1400 meter to a specific application. These include three (3) jumpers, two (2) binary dip switches, and three (3) decimal rotary switches.

The function of these elements are as follows:

1. The **Offset Oscillator**, set by an 8-position DIP switch, is used to set the meter for the pipe size or tee mounted sensor model number.
2. The **Update Period Generator**, set by Jumper J2, is required for controlling the internal logic and timing functions required for operation of the meter. This setting influences many other settings in the meter as well as the resolution of the readouts.
3. The **Rate Multiplier**, set by the three (3) 10-position rotary switches, is used to finish the calibration of the meter to a given pipe size or sensor model number.
4. The **Rate Display Decimal Point**, set by Jumper J5, is a non-functional setting and is only used when the meter user wishes to adopt this option.
5. The **Totalizer Scaler**, set by Jumper J5, is the final control of the resolution of the Totalizer Display.
6. The **Totalizer Divisor**, set by a 10-position DIP switch, is used to control input to the totalizer as required by the Update Period Generator setting to provide an accurate total.

**Figure 10: Board layout showing switch and readout locations**

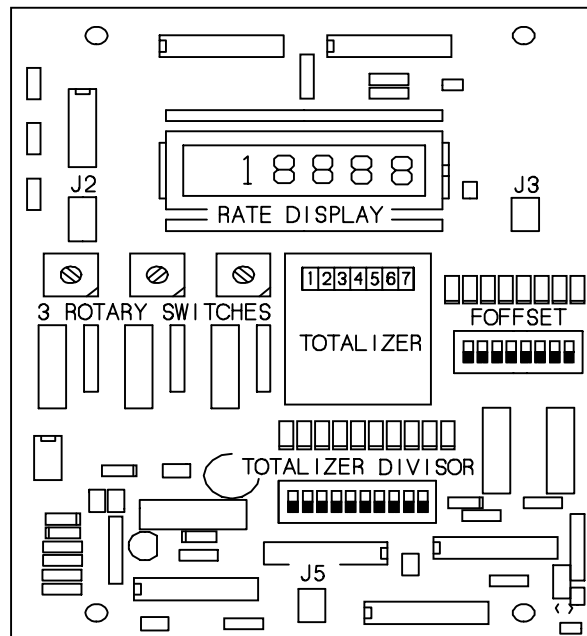

**Factory Default Settings**

The Series 1400 Meter is capable of accepting settings that will produce readouts in various units; gallons, liters, cubic feet, cubic meters, etc. and in various multiples thereof; single, 10's, 100,s, 1000,s, etc. As shipped, the meter is preset to gallons or multiples thereof. J2, J3, J5, and the Totalizer Divisor are preset for the values shown below.

J2 Update Period Generator:  
**Set 8 sec.**

J3 Display Decimal Point:  
**Set None**

J5 Totalizer Scaler:  
**Set x1**

10-Position Binary DIP Switch (Totalizer Divisor):  
**Set 750**

**Figure 11: Factory Default Settings**

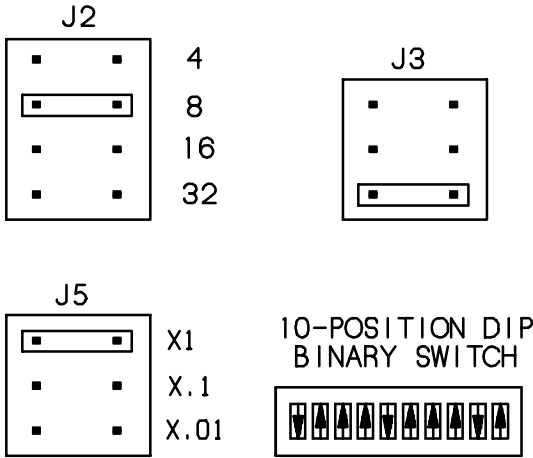

The following pages tabulate, by Sensor Part Number and Pipe Size, the settings for the Offset Oscillator and Update Period Generator appropriate to the factory default settings given above. In addition, the scale multipliers for the Rate and the Totalizer readouts for each setup are given. An estimate of battery life, based on a flow rate of 10 feet per second is also included in the tabulation. Expected battery life at lower flow rates is significantly longer, and in most cases should achieve the maximum of 5 years.

If the operational requirements of the specific installation are not satisfied by the recommended default values; if the flow units are desired in volumetric units other than gallons, e.g. cubic feet, liters, etc.; or for information on, or clarification of the information contained herein; **please consult DATA INDUSTRIAL.**

## Data Industrial Series 1400 Manual

### Matching Calibration to Master Meters

Given a flowmeter calibrated by the above method, it is simple to recalibrate the meter to match a master meter. The procedure is:

1. Establish a flow rate in the actual pipe. If possible, the rate should be close to the average flow expected in the installation.
2. At the position where the meter will actually be located, measure the flow rate with the master, reading A.
3. Install the Data Industrial meter in the same location, and measure the flow rate with the Data Industrial meter, reading B.
4. Read the **M** setting on the Data Industrial meter. This is the setting of the three decimal rotary switches.
5. Reset **M** to read **M\* A/B**.
6. Wait at least two (2) display update cycles, to check the display and confirm that the procedure has been effective.

### Example:

Master Meter Rate Reading  
**A**= 637 GPM

Series 1400 Rate Reading  
**B**= 652 GPM

Series 1400 **M** Setting  
**M**= 836



Calculate new **M**,



$$\mathbf{M} = \frac{836 \times 637}{652} = 816.7$$

Reset rotary switches to **817**

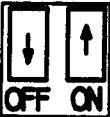
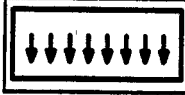
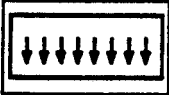
Sensors ... All M Series Insert Style

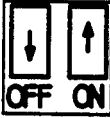

Nominal Pipe Size ... 3 inch

Schedule / Class	10S	PVC 125	PVC 160
Inside Diam. (in.)	3.334	3.284	3.230
Flow Area (sq. ft.)	0.06063	0.05882	0.05690
Flow @ 10 ft / sec (GPM)	272	264	255
<b>K</b>	5.2887	5.3529	5.0975
Offset Frequency	-0.2175	-0.3064	0.0023
Set FOFFSET 			
Set Rotary Switches	331	335	319
Rate Multiplier (GPM)	1	1	1
Total Multiplier (Gal)	100	100	100
Batt. Life @ 5 fps (yrs)	4.9	4.9	4.9

Schedule / Class	Sched 40	Sched 80	
Inside Diam. (in.)	3.068	2.900	
Flow Area (sq. ft.)	0.05134	0.04587	
Flow @ 10 ft / sec (GPM)	230	206	
<b>K</b>	4.4839	3.8381	
Offset Frequency	0.0420	0.0502	
Set FOFFSET 			
Set Rotary Switches	280	240	
Rate Multiplier (GPM)	1	1	
Total Multiplier (Gal)	100	100	
Batt. Life @ 5 fps (yrs)	5.0	5.0	

Sensor ... All M Series Insert Style

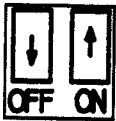

Nominal Pipe Size ... 4 Inch

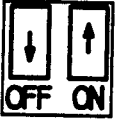
Schedule / Class	40		
Inside Diam. (in.)	4.026		
Flow Area (sq. ft.)	0.08840		
Flow @ 10 ft / sec (GPM)	397		
<b>K</b>	7.9322		
Offset Frequency	0.0724		
Set FOFFSET	 		
Set Rotary Switches	496		
Rate Multiplier (GPM)	1		
Total Multiplier (Gal)	100		
Batt. Life @ 5 fps (yrs)	5.0		

Schedule / Class			
Inside Diam. (in.)			
Flow Area (sq. ft.)			
Flow @ 10 ft / sec (GPM)			
<b>K</b>			
Offset Frequency			
Set FOFFSET			
Set Rotary Switches			
Rate Multiplier (GPM)			
Total Multiplier (Gal)			
Batt. Life @ 5 fps (yrs)			

Sensor ... All M Series Insert Style

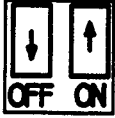
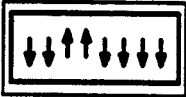

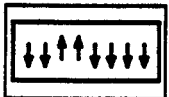
Nominal Pipe Size ... 6 Inch

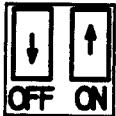
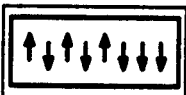
Schedule / Class	10S	PVC 125	40
Inside Diam. (in.)	6.357	6.217	6.065
Flow Area (sq. ft.)	0.2204	0.2108	0.2006
Flow @ 10 ft / sec (GPM)	989	946	900
<b>K</b>	23.4448	21.8658	21.2116
Offset Frequency	0.6558	0.3725	0.6485
Set FOFFSET 			
Set Rotary Switches	147	137	133
Rate Multiplier (GPM)	10	10	10
Total Multiplier (Gal)	1000	1000	1000
Batt. Life @ 5 fps (yrs)	5.0	5.0	5.0

Schedule / Class	80		
Inside Diam. (in.)	5.761		
Flow Area (sq. ft.)	0.1810		
Flow @ 10 ft / sec (GPM)	814		
<b>K</b>	18.6031		
Offset Frequency	0.3869		
Set FOFFSET 			
Set Rotary Switches	116		
Rate Multiplier (GPM)	10		
Total Multiplier (Gal)	1000		
Batt. Life @ 5 fps (yrs)	5.0		

Sensor ... All M Series Insert Style

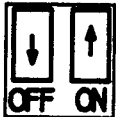
Nominal Pipe Size ... 8 Inch

Schedule / Class	40		
Inside Diam. (in.)	7.981		
Flow Area (sq. ft.)	0.3474		
Flow @ 10 ft / sec (GPM)	1559		
<b>K</b>	38.9740		
Offset Frequency	0.0403		
Set FOFFSET	 		
Set Rotary Switches	244		
Rate Multiplier (GPM)	10		
Total Multiplier (Gal)	1000		
Batt. Life @ 5 fps (yrs)	5.0		

Schedule / Class			
Inside Diam. (in.)			
Flow Area (sq. ft.)			
Flow @ 10 ft / sec (GPM)			
<b>K</b>			
Offset Frequency			
Set FOFFSET			
Set Rotary Switches			
Rate Multiplier (GPM)			
Total Multiplier (Gal)			
Batt. Life @ 5 fps (yrs)			

Sensor ... All M Series Insert Style

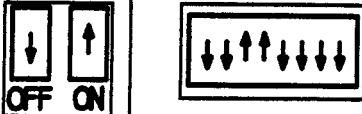

Nominal Pipe Size .. 10 Inch

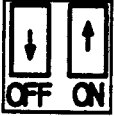
Schedule / Class	40		
Inside Diam. (in.)	10.020		
Flow Area (sq. ft.)	0.5476		
Flow @ 10 ft / sec (GPM)	2458		
<b>K</b>	63.8689		
Offset Frequency	0.6385		
Set FOFFSET			
Set Rotary Switches	399		
Rate Multiplier (GPM)	10		
Total Multiplier (Gal)	1000		
Batt. Life @ 5 fps (yrs)	5.0		

Schedule / Class			
Inside Diam. (in.)			
Flow Area (sq. ft.)			
Flow @ 10 ft / sec (GPM)			
<b>K</b>			
Offset Frequency			
Set FOFFSET			
Set Rotary Switches			
Rate Multiplier (GPM)			
Total Multiplier (Gal)			
Batt. Life @ 5 fps (yrs)			

Sensor ... All M Series Insert Style

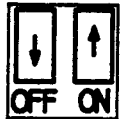
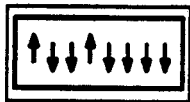
Nominal Pipe Size .. 12 Inch

Schedule / Class	10S	40	
Inside Diam. (in.)	12.000	11.966	
Flow Area (sq. ft.)	0.7854	0.7810	
Flow @ 10 ft / sec (GPM)	3533	3513	
<b>K</b>	91.4402	89.1208	
Offset Frequency	0.9070	1.6447	
Set FOFFSET   			
Set Rotary Switches	572	557	
Rate Multiplier (GPM)	10	10	
Total Multiplier (Gal)	1000	1000	
Batt. Life @ 5 fps (yrs)	4.7	4.7	

Schedule / Class			
Inside Diam. (in.)			
Flow Area (sq. ft.)			
Flow @ 10 ft / sec (GPM)			
<b>K</b>			
Offset Frequency			
Set FOFFSET 			
Set Rotary Switches			
Rate Multiplier (GPM)			
Total Multiplier (Gal)			
Batt. Life @ 5 fps (yrs)			

Sensor ... All M Series Insert Style

Nominal Pipe Size .. 16 Inch

Schedule / Class	30		
Inside Diam. (in.)	15.250		
Flow Area (sq. ft.)	1.2684		
Flow @ 10 ft / sec (GPM)	5693		
<b>K</b>	157.6132		
Offset Frequency	0.3255		
Set FOFFSET			
Set Rotary Switches	985		
Rate Multiplier (GPM)	10		
Total Multiplier (Gal)	1000		
Batt. Life @ 5 fps (yrs)	4.2		

Schedule / Class			
Inside Diam. (in.)			
Flow Area (sq. ft.)			
Flow @ 10 ft / sec (GPM)			
<b>K</b>			
Offset Frequency			
Set FOFFSET			
Set Rotary Switches			
Rate Multiplier (GPM)			
Total Multiplier (Gal)			
Batt. Life @ 5 fps (yrs)			

**SPECIFICATIONS**

**MODEL 1400**

Dimensions: 5.88"(150mm) W X 7.38"(188mm) H X 3.50"(89mm) D.

Weight: 4 lbs - Display Only  
8 lbs - with 220MB sensor

Case Construction: Cast Aluminum, acrylic cover  
Temperature Ranges: - 10 C (24 F) to 60 C (140 F)  
Calibration Ranges: 1 to 20 ft/sec fluid velocity  
Accuracy: +/- 1% of full scale with factory calibration;  
field calibratable to +/- 0.5% of actual  
Linearity: +/- 1% over the 20:1 turn down ratio  
Battery Life: 3 to 5 years average dependent upon totalizer pulse rate

**SENSORS**

**Wetted materials for all sensors:**

- Impeller: Tefzel
- Bearing: Tefzel
- Housing Glass-reinforced polyphenylene sulfide (PPS) Fortron
- Shaft: Tungsten carbide
- O-rings: Ethylene Propylene (EPDM)

**Sleeve and Mounting adapter for 220MB, 225MB, 226MB:**

Sleeve: Admiralty Brass UNS C44300  
Mounting Adapter: Valve Bronze UNS C83600

**Sensor Sleeve and Mounting adapter for 220MSS, 226MSS:**

Sleeve: 304 Stainless steel  
Mounting adapter: 316 Stainless steel

**Tee materials for 228MB, 228MC, 228MS, 250MB, 220MP**

- 228MB- Cast Bronze, Class 125
- 228MC- Cast Iron, Class 125
- 228MS- Cast 316 Stainless steel, Class 150
- 250MB- Cast Valve Bronze UNS C83600
- 220MP- Type 1 PVC, ASTM D-2462,D-2467, Schedule 80

**Pressure and Temperature Rating:**

Depends on hardware configurations. See following diagrams.

**PRESSURE/TEMPERATURE DIAGRAMS FOR DATA INDUSTRIAL FLOW SENSORS**

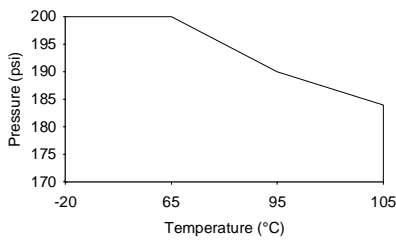

**228BR**

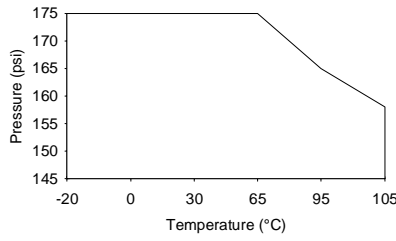

**228CB**

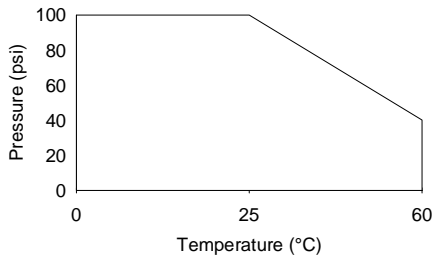

**220P**

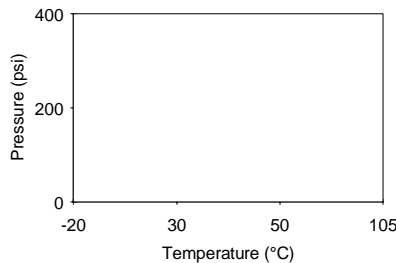

**250BR**

## Warranty

Data Industrial Corporation ("Seller") of 11 Industrial Drive, Mattapoisett, Massachusetts 02739, U.S.A., warrants to the original purchaser of its product that such product manufactured by Data Industrial Corporation shall be free from defects in materials or workmanship when installed, serviced and operated according to Data Industrial corporation instructions or in other such normal use. This warranty is effective for a period of 12 months from the date of installation by the Purchaser or 18 months from the date of shipment by the "Seller" whichever occurs or terminates first. This limited warranty does not cover damage or loss resulting from corrosion or erosion caused by acids or other chemicals or negligent installation improper operation, misuse, accident, unauthorized repair or substitution of components other than those provided by the "Seller", and does not cover limited life components such as bearings, shafts, impellers where wear rate is a function of application. Any component not manufactured by the "Seller" but included in its products shall not be covered by this warranty and is sold only under such warranty as the manufacturer may provide.

If Buyer or Purchaser wishes to make a claim hereunder, he shall send written notice of any defect within the warranty period, to "Seller" at the above address. "Seller" may at its sole option instruct Buyer to ship subject part, postage prepaid, to the "Seller" at above address or authorize a representative to inspect the part on site. "Seller" will at its sole option repair or replace any effective product covered by this warranty. If Buyer makes repairs or alterations to any product or part covered by this warranty without "Sellers" prior written approval, this warranty shall be null and void.

The foregoing shall constitute Buyers or Purchasers sole and exclusive remedy against "Seller", and no other remedy, including but not limited to, incidental or consequential damages for personal injury, loss of fluids, gases or other substances or for loss of profits or injury to property or person shall be available to the Buyer or Purchaser. The warranty extended herein shall be in lieu of any other implied warranty of merchantability or fitness for a particular purpose, and seller shall bear no liability for representatives or retail sellers. In no event shall Data Industrial Corporation be liable for any contingent, incidental, or consequential damage or expenses due to partial or complete inoperability of its product.

All rights reserved. No part of this work covered by the copyrights hereon may be reproduced or copied in any form or by any means - graphic, electronic, or mechanical, including photocopying, recording, taping, or information and retrieval systems - without written permission of Data Industrial.

Copyright © 1993  
Data Industrial Corporation  
11 Industrial Drive  
Mattapoisett, Ma. 02739  
www.dataindustrial.com  
email: sales@dataindustrial.com  
508-758-6390  
FAX: 508-758-4057